

MELAMINED PANEL

POLAR BIRCH	D-9420 BS
LIGHT BEECH	D-9240 BS
BEECH	R24048 MO
DARK WALNUT	D-1925 PR
CHERRY MARBELLA	R42006 SD
WHITE	6459 PE
GREY	U-112 PE
GRAPHITE	U-164 PE
AMBER OAK	K006 SN/PW
ARCTIC OAK	K005 PS/PW
CRAFT OAK	K002 SN/PW
SALEVE WALNUT	R30042 MO
AMERICAN OAK	R20119 LN
GRAPHITE OAK	R20065 MO

METAL

WHITE	RAL 9016
SILVER	RAL 9016
ANTHRACITE	RAL 7016
BLACK	RAL 9005
SILVER AND VARNISH (BLOG AND TRIO) CHROMIUM (ARCADIUS)	RAL 9006 + LACQUER

HPL LAMINATE

VICENZA OAK	H3157
BRANSON TRUFFLE ACACIA	H1253
DAVOS TRUFFLE OAK	H3133
WILD NATURAL OAK	H1318
CHICAGO CONCRETE LIGHT-GRAY	F186
WHITE CARRARA MARBLE	F204
GRIGIA PIETRA BLACK	F206
LIGHT GRAY	U708
VELVET BLACK	U899
GRAY CUBANITE	U767

ACRYLUX

WHITE GLOSS	6000X
GRAY	85384X
BLUE SEA	4670X
GRAY	85383X
BLACK	8421X
COBALT	4644X
RED	3362X
SNOW WHITE MATT	1982MX
LIGHT GRAY MATT	85468MX
GRAY MATT	85383MX
BLACK MAT	8421MX
NAVY BLUE MATT	4702MX

GLASS - MODESTY PANELS

ANTISOL BLACK
ANTISOL GRAPHTE
MILK-WHITE

THE MANUFACTURER RESERVES THE RIGHT TO INTRODUCE CONSTRUCTION MODIFICATIONS AND CHANGES OF PARAMETERS NOT DETERIORATING GENERAL PRODUCTS' CHARACTERISTICS. THIS CATALOGUE DOES NOT CONSTITUTE AN OFFER IN LEGAL SENSE AND IS PUBLISHED FOR INFORMATION PURPOSES ONLY.

CONTENTS

OFFICE FURNITURE

VIND



4-5

SORENO



6

SKY PREMIUM



7

ARCADIUS



8

AUTTICA



9-10

BRAVO



11-12

BLOG & TRIO



13-17

GRAND



18-19

OSKAR



20



OFFICE FURNITURE - VIND

APPROXIMATE LEAD TIME - UP TO 12 WEEKS.

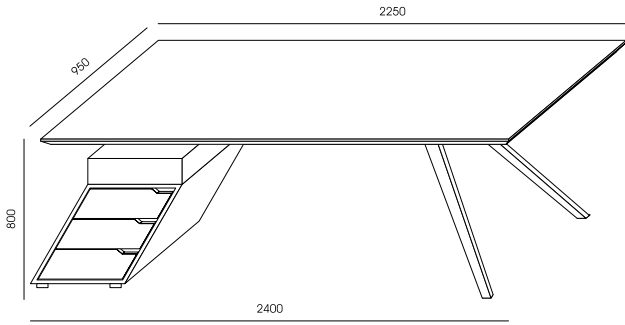

VN-1L

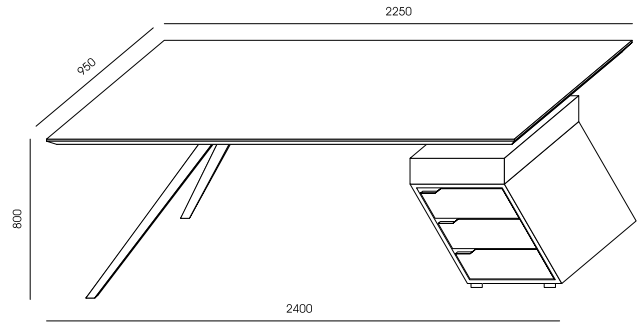

VN-1P

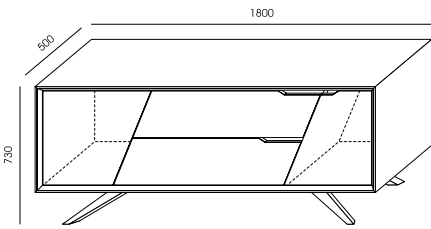

VN-2

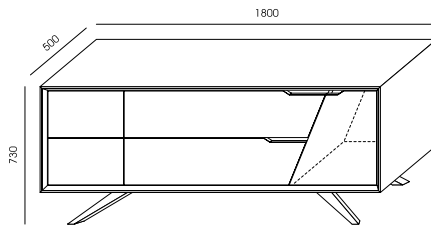

VN-3

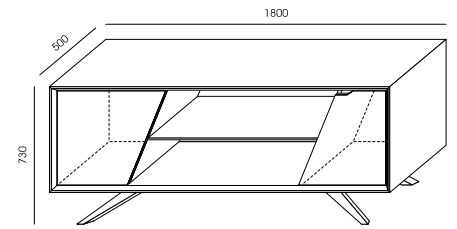

VN-4

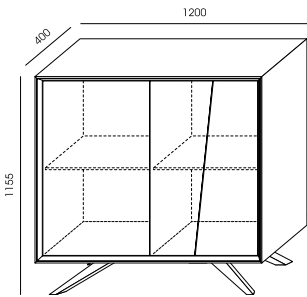

VN-5

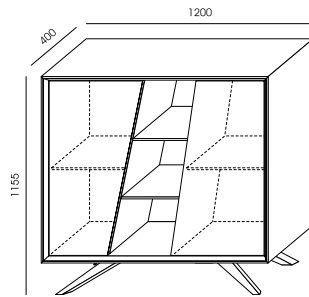

VN-6

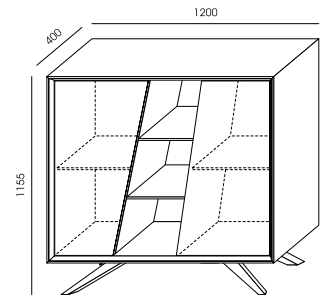

VN-7

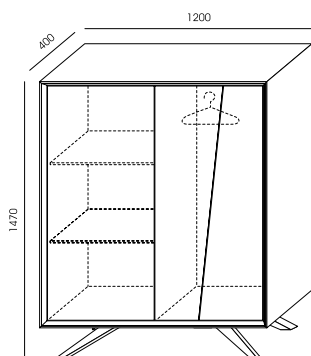

VN-8

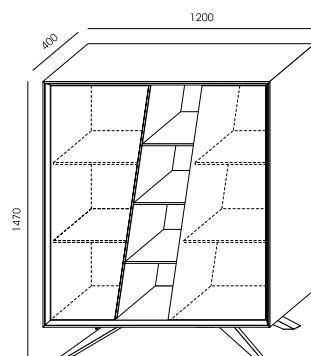

VN-9

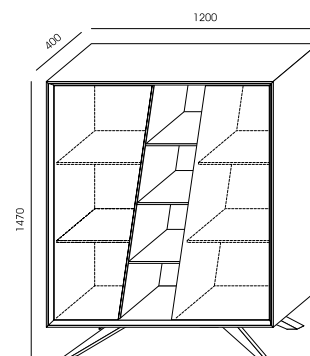

VN-10

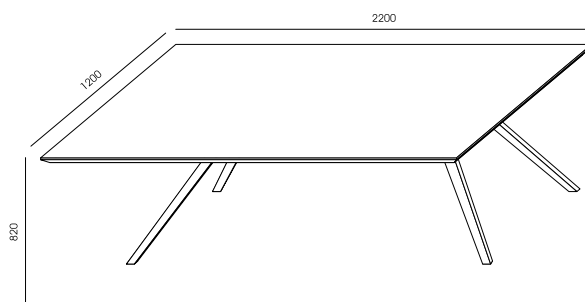

VN-11

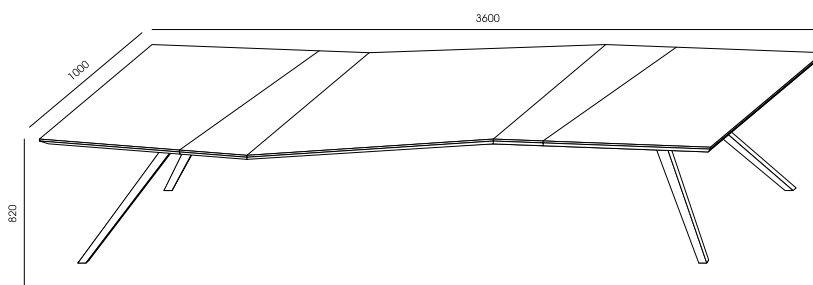

VN-12

DESKTOPS AND TABLE TOPS - QUARTZ SINTER.
 PEDESTAL AND CABINET CARCASSES - LACQUERED MDF.
 FRONTS OF THE CABINETS - QUARTZ SINTER + LACQUERED MDF.
 POWDER COATED METAL FRAME - RAL9005
 TWO COLOUR VERSIONS AVAILABLE:

VERSION I
 SINTER - NATURALI BIANCO STATUARIO VENATO
 CABINET CARCASSES, PEDESTAL BOTOM PART - LACQUERED MDF - BLACK RAL 9005
 PEDESTAL RISER - BEIGE NCS 1002-Y
 METAL - RAL 9005

VERSION II
 SINTER - NATURALI NOIR DESIR LUCIDATO
 CABINET CARCASSES, PEDESTAL BOTTOM PART - LACQUERED MDF ANTHRACITE RAL 7021
 PEDESTAL RISER - BROWN NCS 5020 Y-40R
 METAL - RAL 9005



OFFICE FURNITURE - SORENO

APPROXIMATE LEAD TIME - UP TO 7 WEEKS (NATURAL VENEER).
APPROXIMATE LEAD TIME - UP TO 5 WEEKS (MELAMINE).

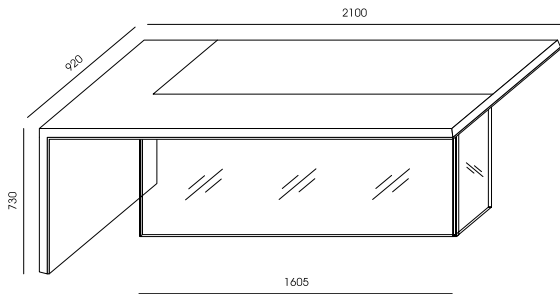

SEO-1
SEO-1M

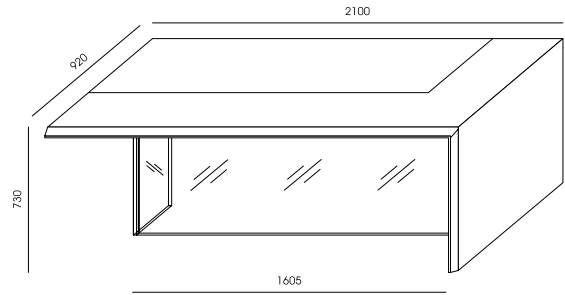

SEO-2
SEO-2M

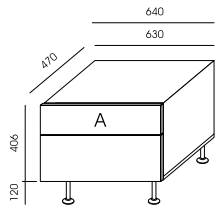

SEO-3
SEO-3M

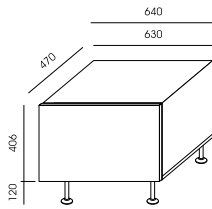

SEO-4
SEO-4M

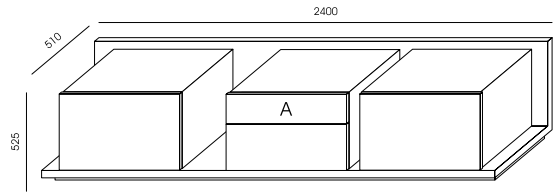

SEO-5
SEO-5M

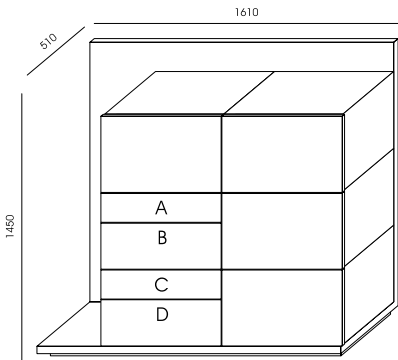

SEO-6
SEO-6M

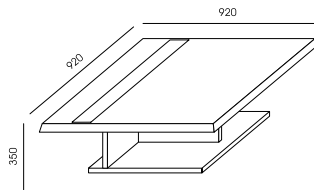

SEO-7
SEO-7M

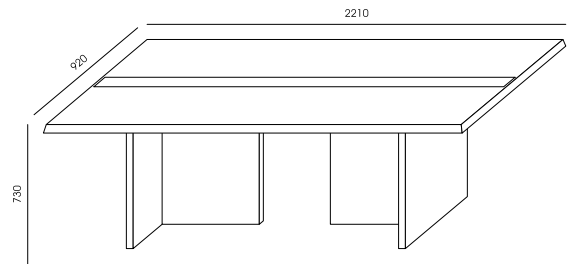

SEO-8
SEO-8M

TABLE TOPS AND SIDES OF DESKS, CABINET FRONTS - NATURAL VENEER - AVAILABLE COLOURS: AMERICAN WALNUT, OAK OR MELAMINED PANEL - AVAILABLE COLOURS: ARCTIC OAK K005PS, AMBER OAK K006SN, DARK WALNUT D1925PR, SALEVE WALNUT R30042 MO, GRAPHITE OAK R20065 MO, GRAPHITE U-164 PE.
THICKNESS OF SEO-8 TABLE TOP - 50 MM.
THICKNESS OF SEO-7 COFFEE TABLE TOP - 40 MM.

FRONTS MARKED WITH A, B, C, D - AVAILABLE OPTIONALLY IN LACQUERED MDF: CLARET RAL 3005 SOFT, GRAPHITE RAL 7021 SOFT, TURQUISE RAL 5009 SOFT.

INSET IN DESKTOPS, MEETING TABLE AND DESK SIDES, CABINET PLINTH - FINISHED WITH FORBO MAT - GRAPHITE.

CABINETS CARCASS - MELAMINED PANEL - GRAPHITE U-164 PE.

DOORS AND DRAWERS - SOFT-CLOSING SYSTEM.

BASE OF SEO-7 - MELAMINED PANELS 25 MM.

BASE OF SEO-7 - MELAMINED PANELS 36 MM.

TABLE LEGS - MELAMINED PANEL 36 MM THICK - GRAPHITE U-164 PE.

IN SEO-1M AND SEO-2M - TABLETOPS MADE OF MELAMINED PANELS, GLASS MODESTY PANELS.

IN SEO-1MM AND SEO-2MM - TABLETOPS AND MODESTY PANELS MADE OF MELAMINED PANELS.

DESK GLASS - TRANSPARENT, TEMPERED GLASS.

OFFICE FURNITURE - SKY PREMIUM



APPROXIMATE LEAD TIME - UP TO 4 WEEKS.

DESKS WITH ELECTRIC HEIGHT ADJUSTMENT

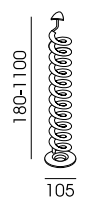
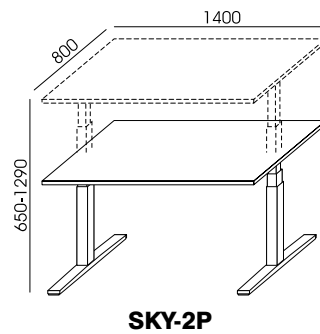
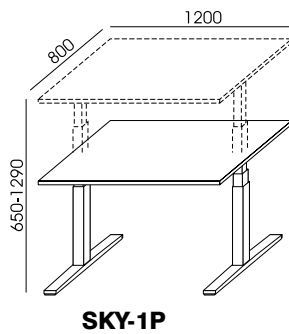
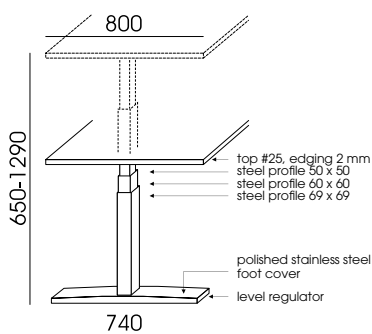

KB-100

CHROMIUM/BLACK

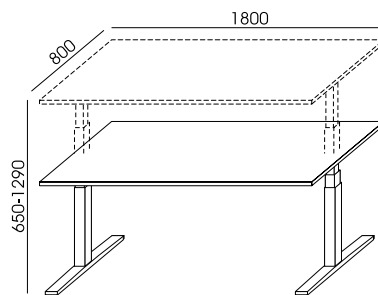
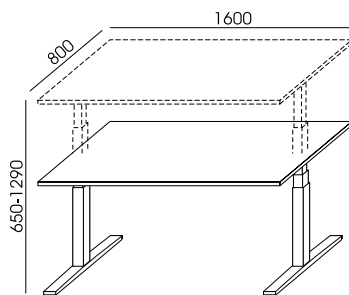

GLASS MODESTY PANELS.
APPROXIMATE LEAD TIME - UP TO 4 WEEKS.

HEIGHT MEMORY MODULE

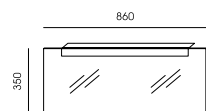

BSZ-1

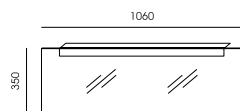

BSZ-2

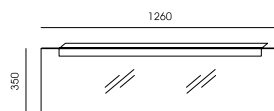

BSZ-3

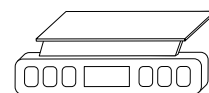

SKY-5

DIGITAL DISPLAY.
THREE MEMORY POSITIONS.
POSSIBILITY OF SETTING THE PREFERRED
MINIMUM AND MAXIMUM HEIGHT.

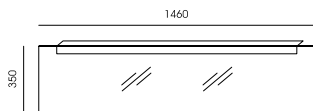

BSZ-4

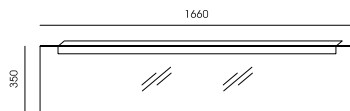

BSZ-5

SMOOTH HEIGHT ADJUSTMENT FROM 650 TO 1290 MM, OPERATED BY BUTTON.
METAL FRAME - POWDER COATED IN BLACK, WHITE OR SILVER.
FEET OF DESKS WITH PADS MADE OF POLISHED STAINLESS STEEL.
25 MM THICK DESKTOP FINISHED WITH 2 MM THICK EDGING.
DESKTOP WITHOUT PORTALS.
FRAME EQUIPPED WITH ANTI-COLLISION SYSTEM.
SENSITIVITY ADJUSTMENT (3 LEVELS) AFTER INSTALLATION OF THE SKY-5 MEMORY MODULE.
NOISE LEVEL - MAX. 43 DB
UNDERDESK METAL BEAM WITH TELESCOPIC ADJUSTMENT AND WITH TWO ELECTRIC MOTORS.
THREE-COLUMN LEGS



OFFICE FURNITURE - ARCADIUS

APPROXIMATE LEAD TIME - UP TO 6 WEEKS.

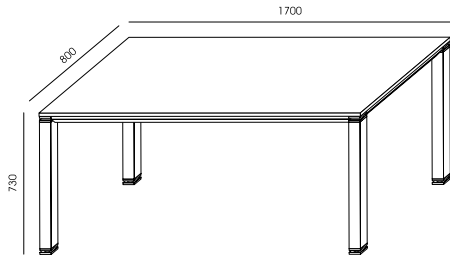

AC-1

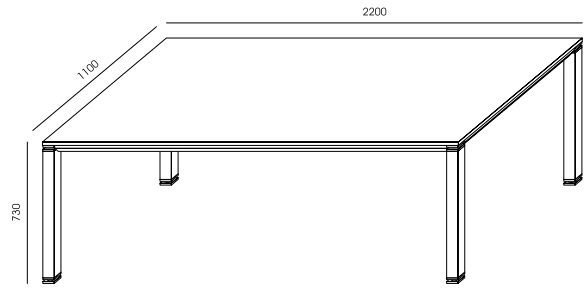

AC-2

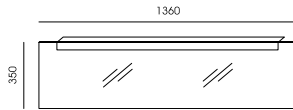

AC-13

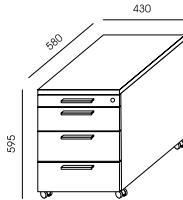

AC-5

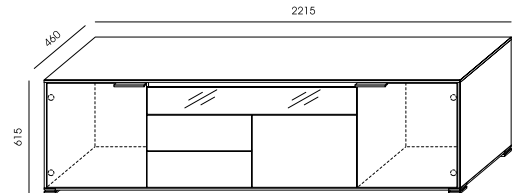

AC-6

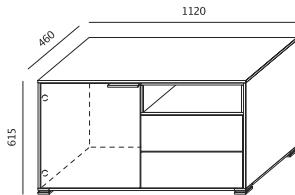

AC-7

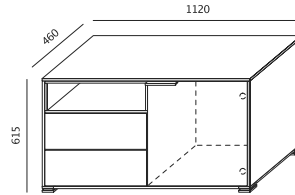

AC-8

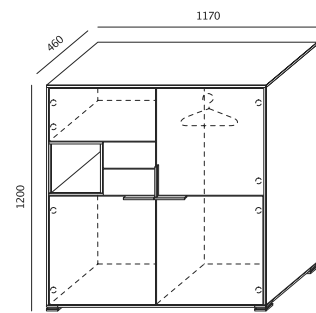

AC-11

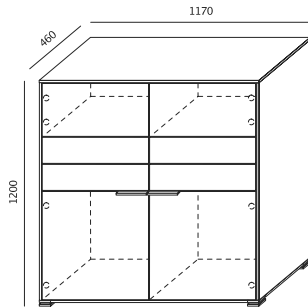

AC-12

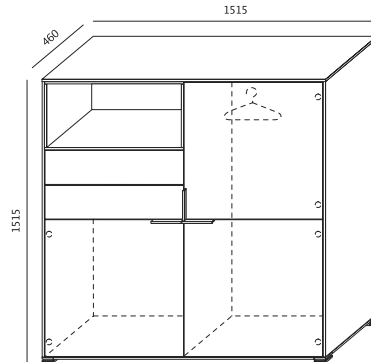

AC-9

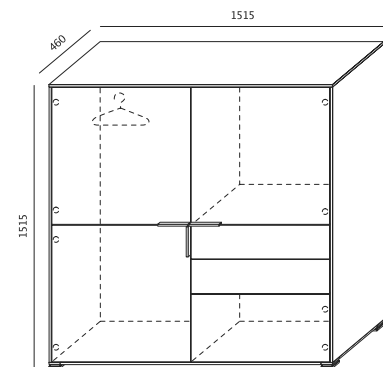

AC-10

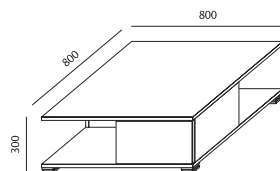

AC-3

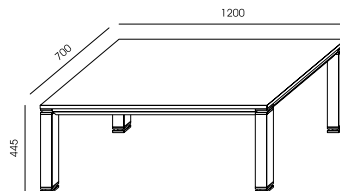

AC-4

MELAMINATED PANEL - AVAILABLE COLOURS FROM WUTEH COLOUR SAMPLER.
THICKNESS OF TABLE TOP OF DESKS AND TABLES - 18 MM.
DESK AND TABLES FRAME, LEGS IN CABINETS, HANDLES - METAL, CHROMED.
LEGS PROFILE - 60X60 MM.

POSSIBILITY OF MOUNTING AC-13 GLASS MODESTY PANEL TO THE AC-1 DESK - AVAILABLE GLASS COLOURS: MILK-WHITE, ANTISOL GRAPHITE, ANTISOL BLACK.

DRAWER WITH GLASS FRONT IN CABINET AC-6 - AVAILABLE GLASS COLOURS: MILK-WHITE, ANTISOL GRAPHITE, ANTISOL BLACK.

DRAWERS WITH PUSH TO OPEN SYSTEM.

TWO-WAY GRAIN DIRECTION IN TALL CABINETS.

AC-5 PEDESTAL - HÄFELE METAL DRAWERS WITH SOFT-CLOSING SYSTEM, CENTRAL LOCK WITH ONE DRAWER OPENING AT A TIME, PENTRAY DRAWER.

OFFICE FURNITURE - AUTTICA



APPROXIMATE LEAD TIME - UP TO 6 WEEKS.

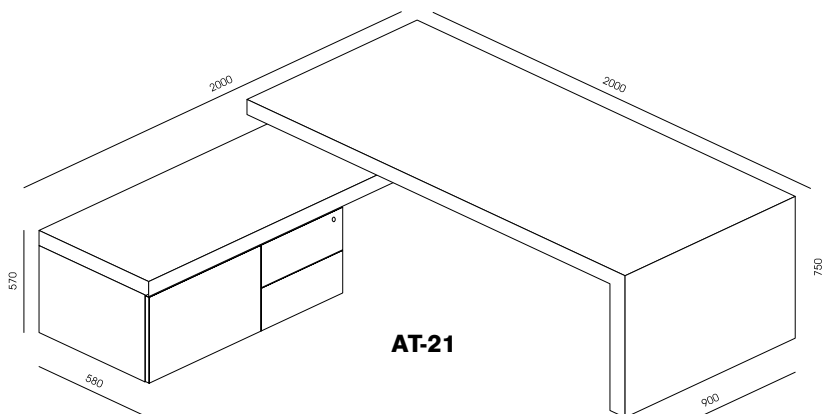

AT-21

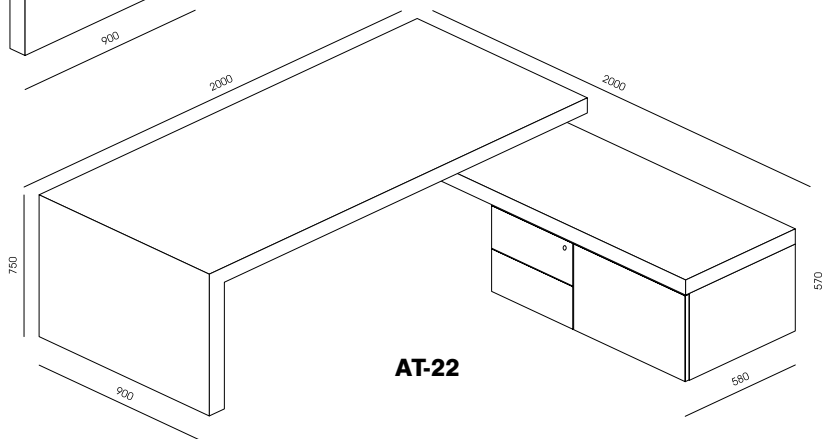

AT-22

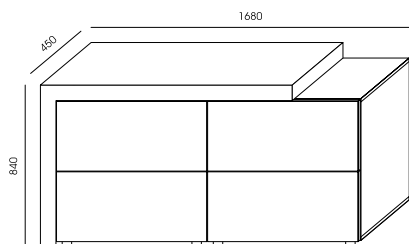

AT-3

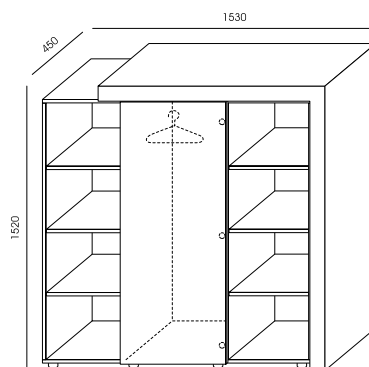

AT-12

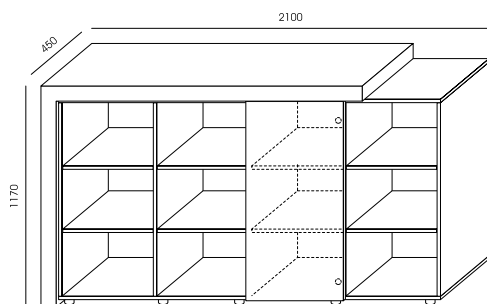

AT-14

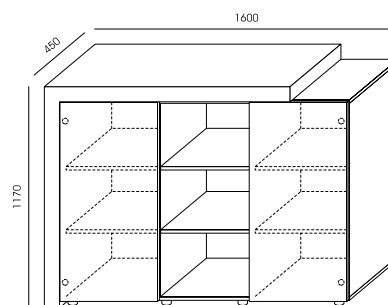

AT-15



OFFICE FURNITURE - AUTTICA

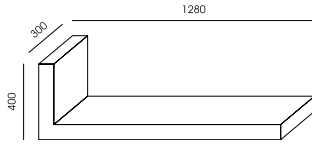

AT-7

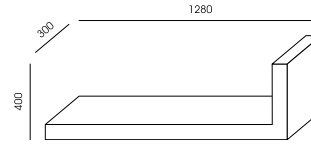

AT-8

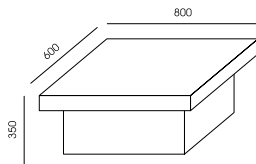

AT-9

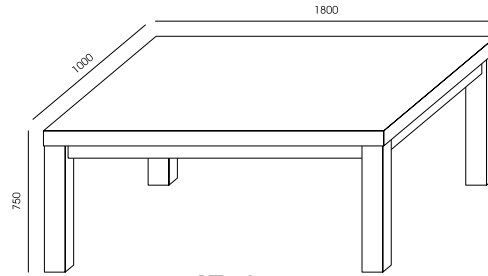

AT-16

THICK ELEMENTS - CELLBOARD 80 MM THICK, FINISHED WITH HPL LAMINATE - AVAILABLE COLOURS FROM WUTEH COLOUR SAMPLER.
CABINET DOOR FRONTS FINISHED WITH HPL LAMINATE - AVAILABLE COLOURS FROM WUTEH COLOUR SAMPLER.
LEFT SIDES OF AT-21 AND AT-22 TOPS FINISHED WITH ANTI-TENSION LAMINATE.
DOORS AND DRAWERS - PUSH TO OPEN SYSTEM.
AT-3 DRAWERS - POSSIBILITY OF HANGING FILES.

OFFICE FURNITURE - BRAVO



APPROXIMATE LEAD TIME - UP TO 4 WEEKS.

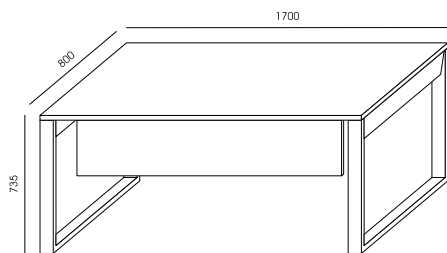

BR-1

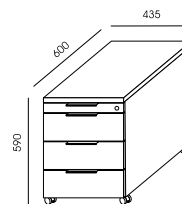

BR-10

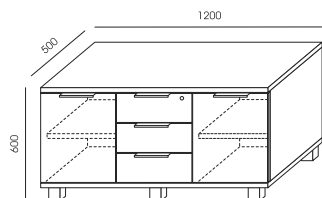

BR-2

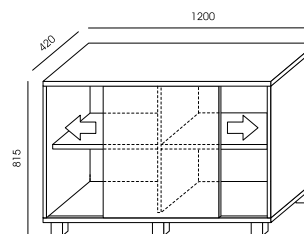

BR-3

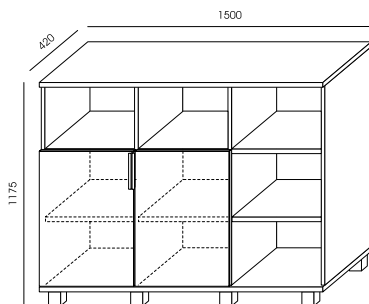

BR-4

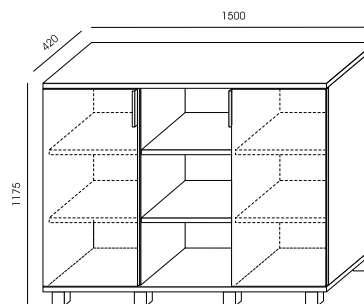

BR-5

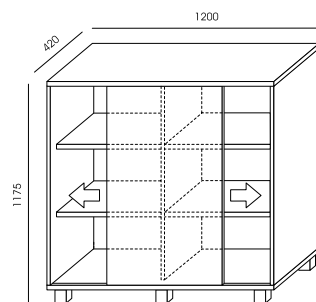

BR-11



OFFICE FURNITURE - BRAVO

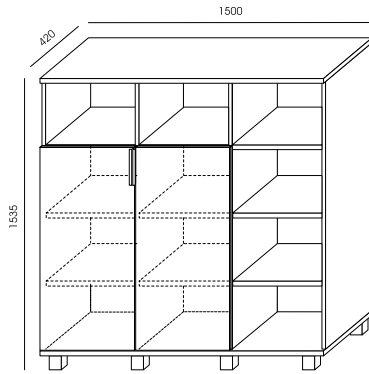

BR-6

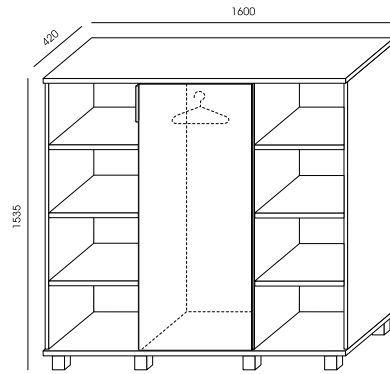

BR-7

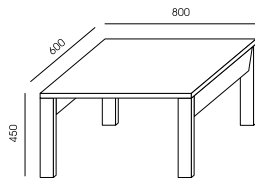

BR-8

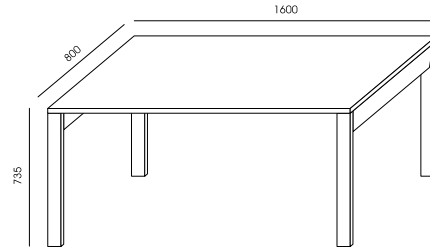

BR-9

TABLE TOPS AND CARCASSES - MELAMINATED PANEL - AVAILABLE COLOURS FROM WUTEH COLOUR SAMPLER. THICKNESS OF TABLE TOP OF DESKS AND TABLES - 25 MM.
 CABINET FRONTS, PEDESTAL FRONTS AND MODESTY PANEL - ACRYLUX PANEL - AVAILABLE COLOURS FROM WUTEH COLOUR SAMPLER.
 DESK AND TABLE FRAMES - POWDER COATED METAL TO RAL COLOURS - AVAILABLE COLOURS FROM WUTEH COLOUR SAMPLER.
 HANDLES AND FEET - AVAILABLE IN SILVER OR BLACK.
 LEGS PROFILE - 70X30 MM.
 SWING DOORS - SOFT-CLOSING SYSTEM.
 CABINET BR-2 AND PEDESTAL BR-10 - HAFELE METAL DRAWERS WITH SOFT-CLOSING SYSTEM, CENTRAL LOCK WITH ONE DRAWER OPENING AT A TIME,
 PEDESTAL INCLUDES PENTRAY DRAWER.

APPROXIMATE LEAD TIME - UP TO 4 WEEKS.

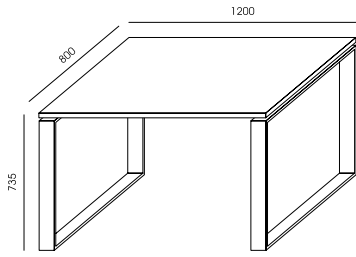

BG-1

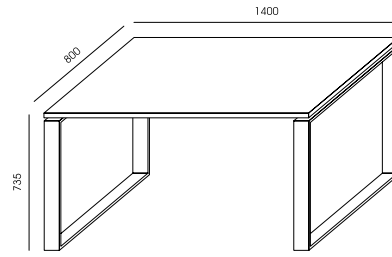

BG-2

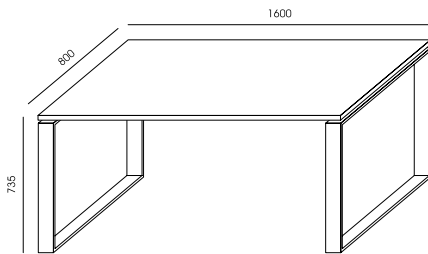

BG-3

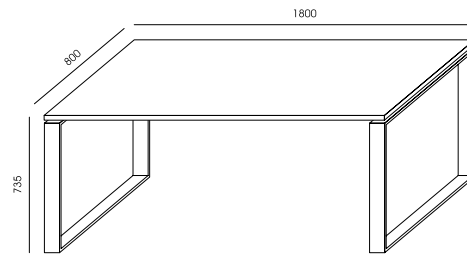

BG-4

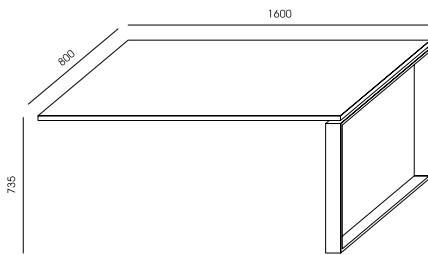

BG-5

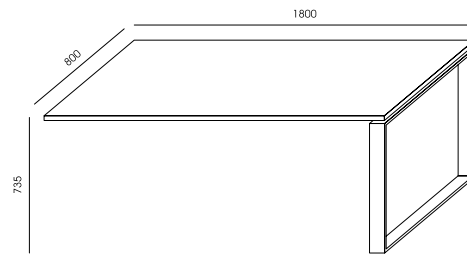

BG-6



OFFICE FURNITURE - HOME OFFICE TRIO

APPROXIMATE LEAD TIME - UP TO 4 WEEKS.

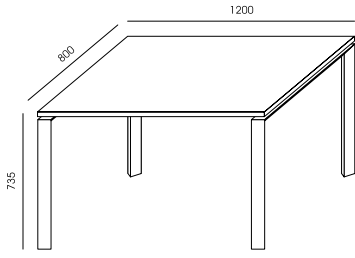

TO-1

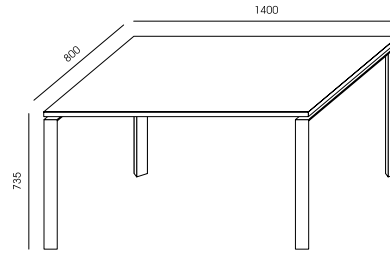

TO-2

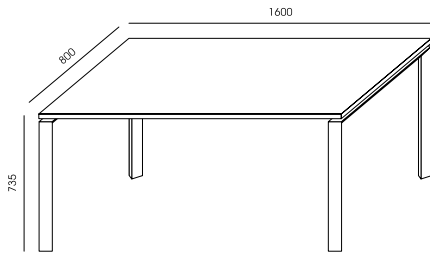

TO-3

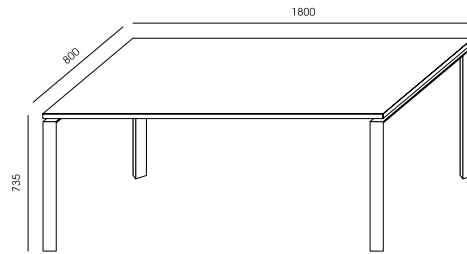

TO-4

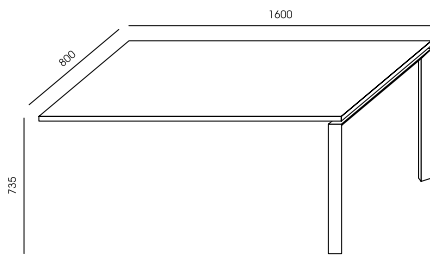

TO-5

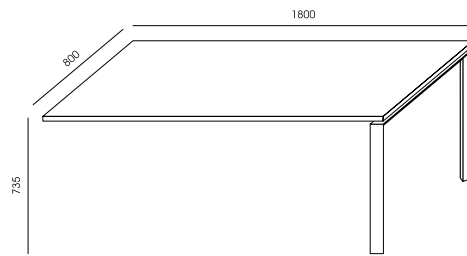

TO-6

APPROXIMATE LEAD TIME - UP TO 4 WEEKS.

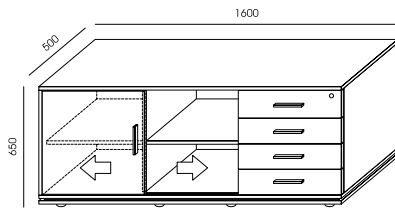

TB-1

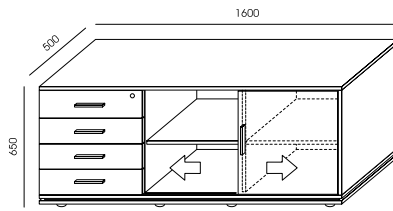

TB-2

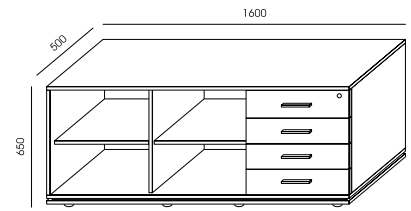

TB-3

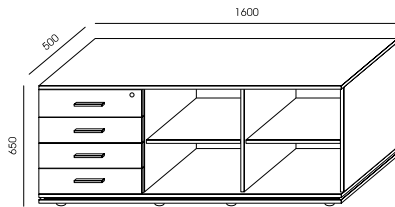

TB-4

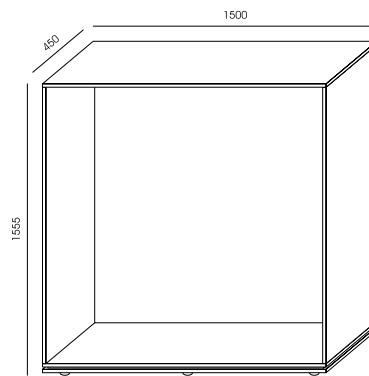

TB-5

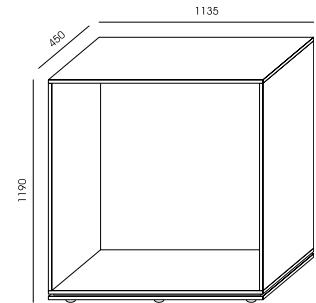

TB-6

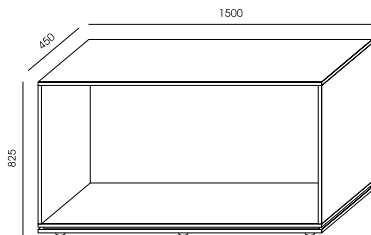

TB-7

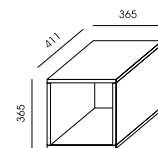

TB-8

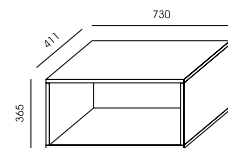

TB-9

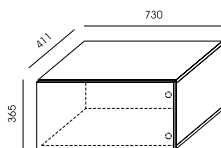

TB-10

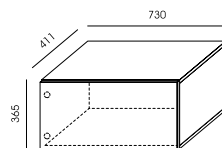

TB-11

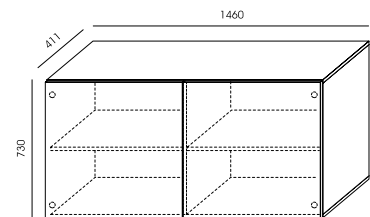

TB-12



OFFICE FURNITURE - HOME OFFICE BLOG & TRIO

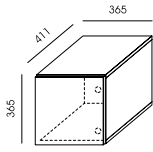

TB-13

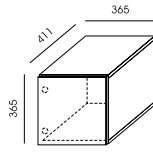

TB-14

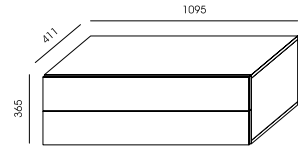

TB-15

EXEMPLARY SETS:

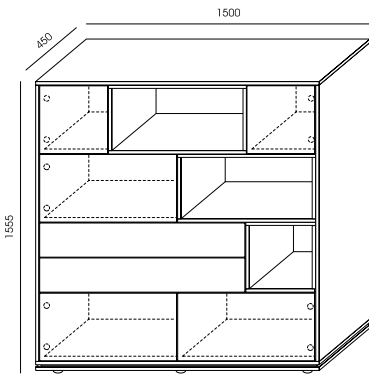

- TB-5 +
- TB-14 + TB-9 + TB-13
- TB-11 + TB-9
- TB-15 + TB-8
- TB-11 + TB-10

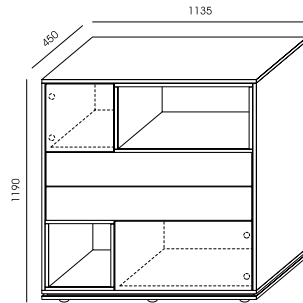

- TB-6 +
- TB-14 + TB-9
- TB-15
- TB-8 + TB-10

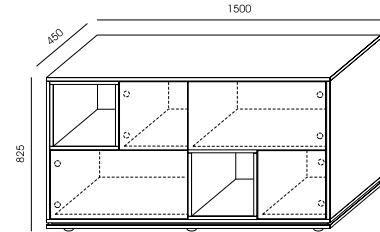

- TB-7 +
- TB-8 + TB-14 + TB-10
- TB-11 + TB-8 + TB-13

MELAMINATED PANEL - AVAILABLE COLOURS FROM WUTEH COLOUR SAMPLER. ADDITIONAL COLOURS AVAILABLE FOR TB CABINETS: CLARET U2656PE AND SEA BLUE U3824.
 THICKNESS OF TABLE TOP - 18 MM.
 DESK FRAMES, CABINET PLINTHS, DESK-SIDE CABINET HANDLES - POWDER COATED METAL - SILVER + LACQUER COATING.
 BLOG LEGS PROFILE - 80X15 MM.
 TRIO LEGS PROFILE - ISOSCELES TRIANGLE, 68X49X49 MM.
 OPTION TO INSTALL MODESTY PANELS BW MADE OF MELAMINATED PANEL TO THE DESKS - AVAILABLE COLOURS FROM WUTEH COLOUR SAMPLER OR GLASS MODESTY PANELS
 BSZ - AVAILABLE GLASS COLOURS: MILK-WHITE, ANTISOL GRAPHITE, ANTISOL BLACK.
 CABINETS PUT INTO RACK - PUSH-TO-OPEN SYSTEM.
 DESK-SIDE CABINETS TB-1, TB-2, TB-3, TB-4 - BLUM DRAWERS WITH SOFT-CLOSING SYSTEM, CENTRAL LOCK.
 POSSIBILITY OF INDIVIDUAL ARRANGEMENT OF THE CABINETS AND RACKS INSIDE TB-5, TB-6, TB-7 CARCASSES.

.....
MODESTY PANELS - 18 MM THICK

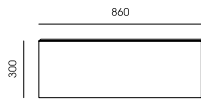

BW-1

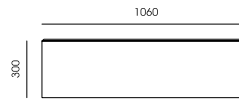

BW-2

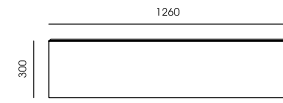

BW-3

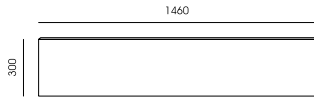

BW-4

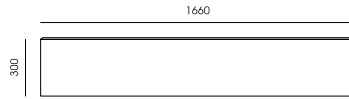

BW-5

.....
MODESTY PANELS
APPROXIMATE LEAD TIME - UP TO 4 WEEKS.

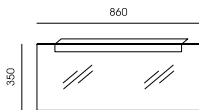

BSZ-1

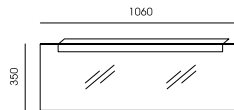

BSZ-2

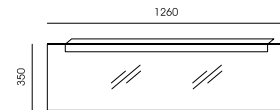

BSZ-3



BSZ-4



BSZ-5

GLASS COLOURS:
ANTISOL BLACK, ANTISOL GRAPHTE, MILKY WHITE



OFFICE FURNITURE - GRAND

APPROXIMATE LEAD TIME - UP TO 4 WEEKS.

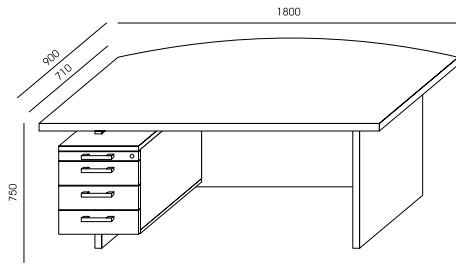

GR-1

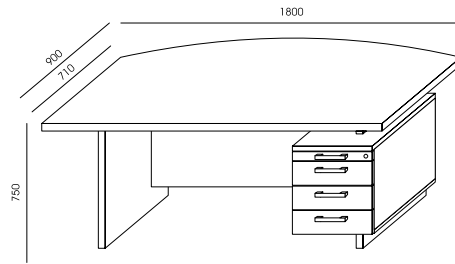

GR-2

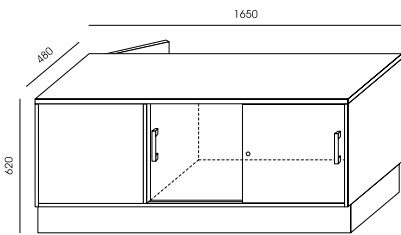

GR-3

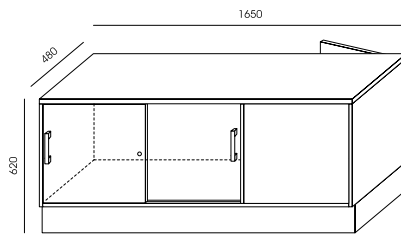

GR-4

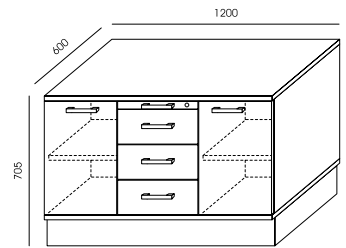

GR-6

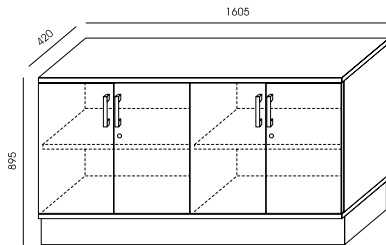

GR-9

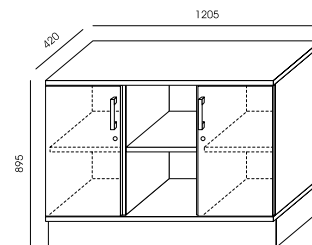

GR-24

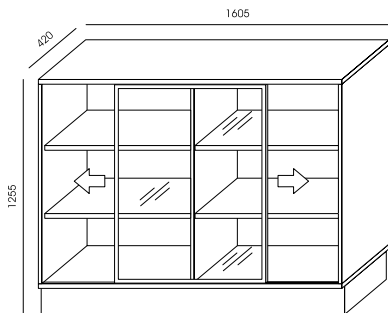

GR-7

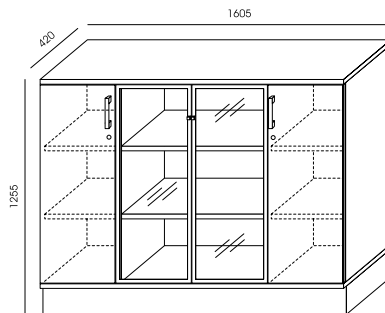

GR-13

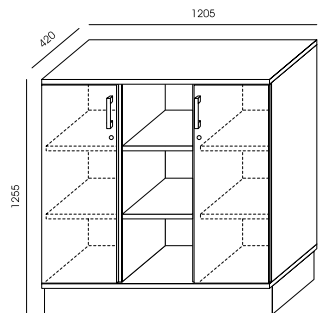

GR-25

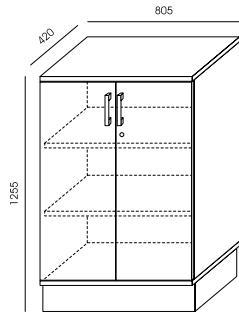

GR-26

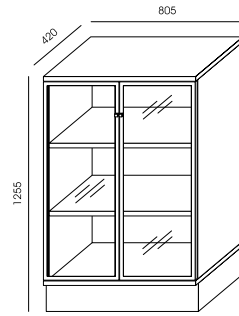

GR-27

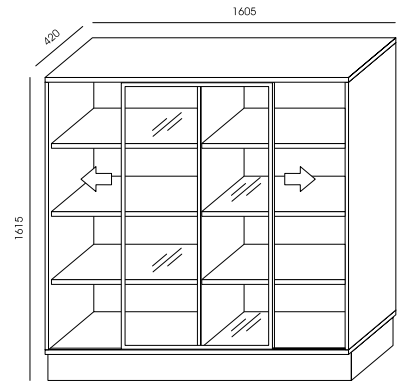

GR-8

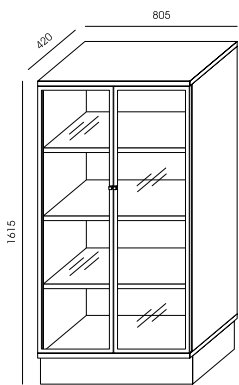

GR-16

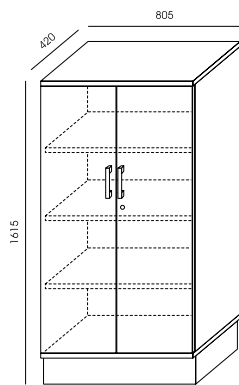

GR-17

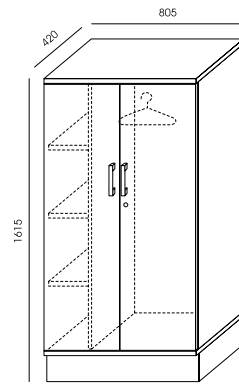

GR-28

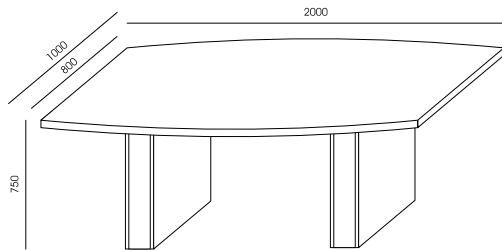

GR-23

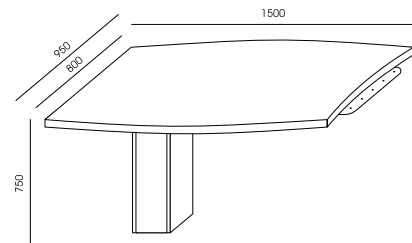

GR-29

EXTENSION FOR THE FRONT OF THE DESK GR-1 OR GR-2

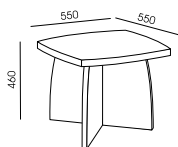

GR-22

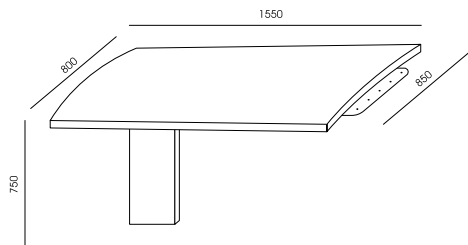

GR-30

EXTENSION FOR THE FRONT OF THE DESK GR-1 OR GR-2

MELAMINATED PANEL - AVAILABLE COLOURS FROM WUTEH COLOUR SAMPLER.
 DESKTOPS AND TABLE TOPS - 40 MM THICK.
 HANDLES - SILVER.
 GLASS - MILK-WHITE IN ALUMINIUM FRAME, SOFT-CLOSING SYSTEM.
 SWING DOORS - SOFT-CLOSING SYSTEM.
 CABINET PLINTHS - 150 MM HIGH.
 HÄFELE METAL DRAWERS WITH SOFT-CLOSING SYSTEM, CENTRAL LOCK WITH ONE DRAWER OPENING AT A TIME, PENTRAY DRAWER.



OFFICE FURNITURE - OSKAR

APPROXIMATE LEAD TIME - UP TO 4 WEEKS.

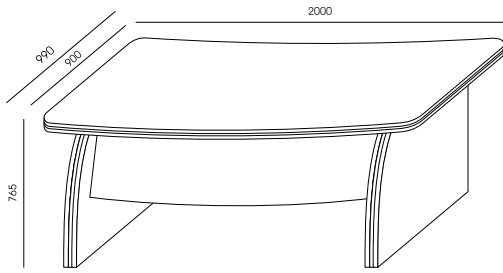

KA-1

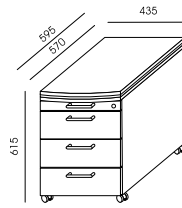

KA-13

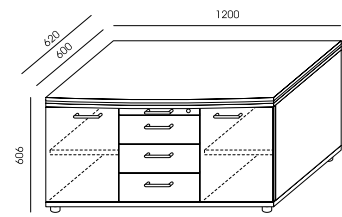

KA-4

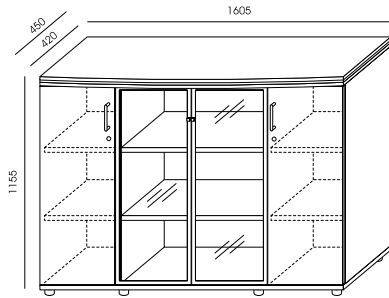

KA-5

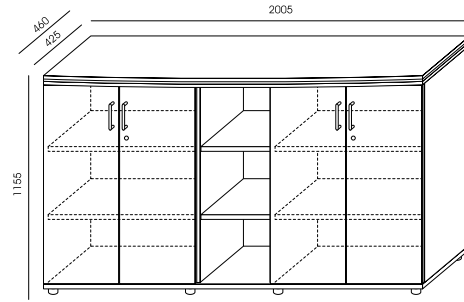

KA-6

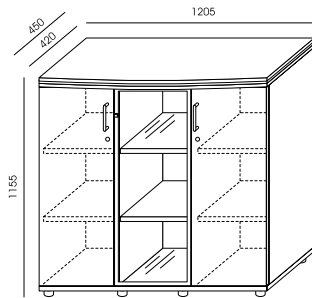

KA-14

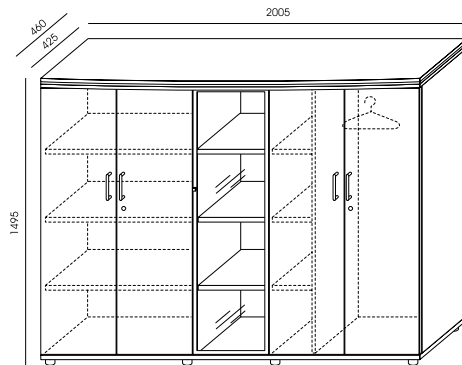

KA-10

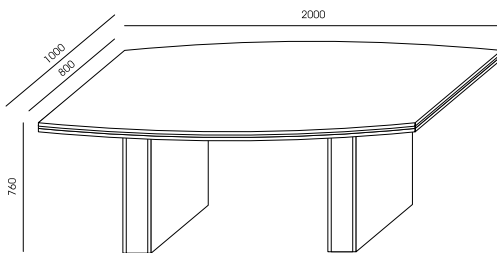

KA-12

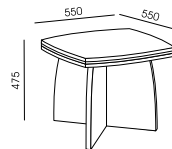

KA-11

MELAMINATED PANEL - AVAILABLE COLOURS FROM WUTEH COLOUR SAMPLER.
 TABLE TOPS AND CABINET TOP PANELS - 48 MM THICK (18 MM + BLACK INSERT 12 MM + 18 MM).
 HANDLES AND FRAMES - BRUSHED STEEL.
 GLASS - ANTISOL BROWN IN ALUMINIUM FRAME, SOFT-CLOSING SYSTEM.
 SWING DOORS - SOFT-CLOSING SYSTEM.
 DRAWERS IN KA-13 AND KA-4 - HÄFELE METAL DRAWERS WITH SOFT-CLOSING SYSTEM, CENTRAL LOCK WITH ONE DRAWER OPENING AT A TIME, PENTRAY DRAWER.



CABLE-PASS WITH COVER

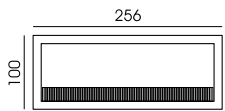

PM-3

PM-3
ANODIZED ALUMINUM

DESKTOP MOUNTED MULTIMEDIA PORTS

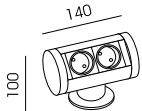

PM-110

2 X MAINS SOCKETS 230V. COLOURS:
BLACK, WHITE, ANODIZED ALUMINUM

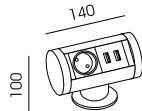

PM-111

1 X 230V MAINS SOCKET, 2 X USB CHARGER, COLO-
URS: BLACK, WHITE, ANODIZED ALUMINUM

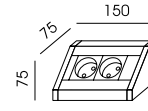

PM-112

2 X MAINS SOCKETS 230V, COLOURS:
BLACK, WHITE, SILVER

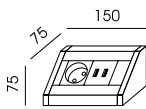

PM-113

1 X 230V MAINS SOCKET, 2 X USB CHARGER,
COLOURS: BLACK, WHITE, SILVER

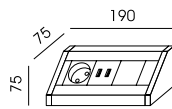

PM-114

1 X 230V MAINS SOCKET, 2 X USB CHARGER,
1 X LOCATION WITH COVER CAP
COLOURS: BLACK, WHITE, SILVER

MULTIMEDIA PORTS MOUNTED IN FI 80 MM HOLE



PM-4

1 X MAINS SOCKETS 230V, 1 X SOCKETS RJ45 CAT.5E,
1 X USB SOCKET. COLOUR: BLACK



PM-5

INDUCTION CHARGER



PM-6

1x 230V MAINS SOCKET, 1 X RJ45 SOCKET CAT.6,
USB CHARGER. COLOUR: BLACK

UNDERDESK MULTIMEDIA PORTS WITH OPENING BOX

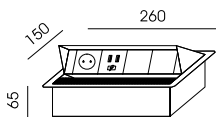

PM-100

1 X 230V SOCKET, 2 X USB CHARGER,
2 LOCATIONS WITH COVER CAP
COLOURS: WHITE, BLACK, SILVER

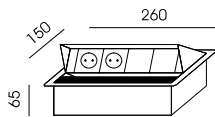

PM-101

2 X 230V SOCKETS, 2 X LOCATIONS WITH COVER CAPS
COLOURS: WHITE, BLACK, SILVER

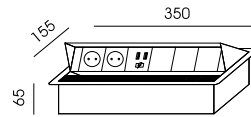

PM-102

2 X 230V SOCKETS, 2 X USB CHARGER,
3 LOCATIONS WITH COVER CAP
COLOURS: WHITE, BLACK, SILVER

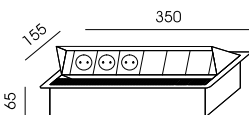

PM-103

3 X 230V SOCKETS, 3 X LOCATIONS WITH COVER CAPS
COLOURS: WHITE, BLACK, SILVER

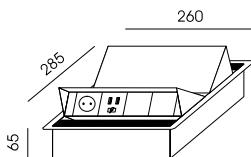

PM-108

2 X INSERTS: 1 X 230V MAINS SOCKET,
2 X USB CHARGER, 2 X LOCATIONS WITH COVER CAPS
COLOURS: WHITE, BLACK, SILVER

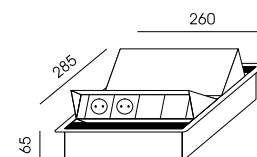

PM-109

2 X INSERTS: 2 X MAINS SOCKETS 230V,
2 X LOCATIONS WITH COVER CAPS
COLOURS: WHITE, BLACK, SILVER



MULTIMEDIA PORTS

MULTIMEDIA PORTS ARE EQUIPPED WITH SUPPLY CABLES.
SOCKETS AVAILABLE IN BLACK, HOUSINGS ACC. TO DESCRIPTION

UNDERDESK MULTIMEDIA PORTS WITH OPENING BOX

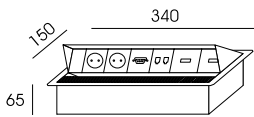

PM-1

2 X MAINS SOCKETS 230V, 2 X RJ45 SOCKETS CAT.5E,
1 X VGA SOCKET, 1 X HDMI SOCKET, 1 X USB SOCKET
COLOURS: SILVER

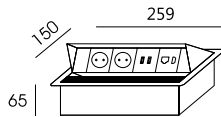

PM-7

1 X 230V MAINS SOCKETS, 2 X RJ45 SOCKETS CAT.6,
1 X HDMI SOCKET, 2 X USB CHARGER
COLOURS: WHITE, BLACK, SILVER

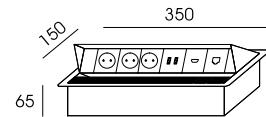

PM-8

3 X MAINS SOCKETS 230V, 1 X SOCKETS RJ45 CAT.5E,
1 X HDMI SOCKET, 2 X USB CHARGER
COLOURS: WHITE, BLACK, SILVER

UNDERDESK MULTIMEDIA PORTS IN FRAME

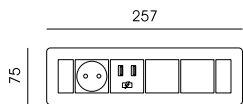

PM-104

1 X 230V SOCKET, 2 X USB CHARGER,
2 X LOCATIONS WITH COVER CAPS
COLOURS: WHITE, BLACK, SILVER

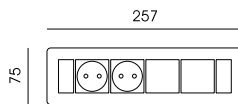

PM-105

2 X 230V SOCKETS, 2 X LOCATIONS
WITH COVER CAPS
COLOURS: WHITE, BLACK, SILVER

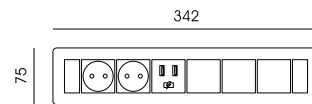

PM-106

2 X 230V SOCKETS, 2X USB CHARGER,
3 X LOCATIONS WITH COVER CAP
COLOURS: WHITE, BLACK, SILVER

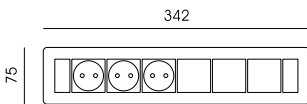

PM-107

3 X 230V SOCKETS, 3 X LOCATIONS WITH COVER CAPS
COLOURS: WHITE, BLACK, SILVER

CONNECTIONS FOR PORTS CONFIGURATION

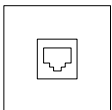

PWM-1

MODULE WITH RJ45 SOCKET CAT. 6 X UTP
KEystone FEMALE/FEMALE COUPLER
COLOUR: BLACK

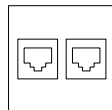

PWM-2

MODULE WITH 2X RJ45 SOCKET CAT. 6 X UTP
KEystone FEMALE/FEMALE COUPLER
COLOUR: BLACK

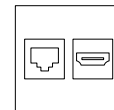

PWM-3

MODULE WITH RJ45 SOCKET CAT. 6 X UTP KEystone
FEMALE/FEMALE COUPLER AND 1 X HDMI FEMALE SOCKET
COLOUR: BLACK

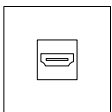

PWM-4

MODULE WITH 1 X HDMI FEMALE SOCKET ON 0.1 M
CABLE WITH FEMALE SOCKET
COLOUR: BLACK

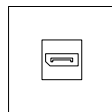

PWM-5

MODULE WITH 1 X DISPLAYPORT FEMALE SOCKET
WITH 3M CABLE WITH MALE PLUG
COLOUR: BLACK

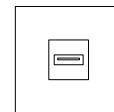

PWM-6

MODULE WITH 1 X USB 2.0 FEMALE SOCKET ON 0.1 M CABLE
WITH FEMALE SOCKET COLOUR: BLACK

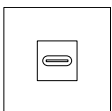

PWM-7

MODULE WITH 1 X USB C FEMALE SOCKET WITH
CABLE 2 M CABLE WITH MALE PLUG
COLOUR: BLACK

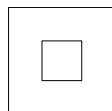

PWM-8

THROUGH MODULE WITH SINGLE KEystone
TYPE SOCKET
COLOUR: BLACK

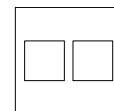

PWM-9

THROUGH MODULE WITH DOUBLE KEystone
TYPE SOCKET
COLOUR: BLACK

